



Premiata dall'ADI (Associazione per il Disegno Industriale) nel 2019 come esempio di innovazione e "sustainable design", Genea è stata la prima collezione che abbiamo sviluppato insieme all'atelier oi. Grazie a un processo esclusivo di curvatura del legno, la spalliera si sdoppia per generare sia i braccioli, sia le gambe anteriori e posteriori.

Honoured by ADI (Industrial Design Association) in 2019 as an example of innovation and sustainable design, Genea was the first collection that we developed with atelier oi. Thanks to an exclusive wood-curving process, the backrest splits into two, forming both the armrests and the front and back legs.



Il marchio della gestione forestale responsabile



# Genea Lazy

design by atelier oï



## Dimensions/Dimensioni

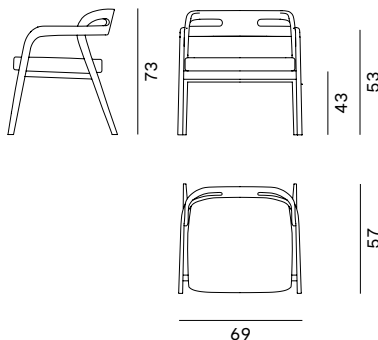

**Solid ash frame**  
**No removable upholstery**  
Telaio in frassino massello  
Tapezzeria non sfoderabile

**L 69 × W 57 H 73**

**Max. per box/Max. per scatola:**

1 pc./1 pz.

**Volume/Volume:**

0,39 m<sup>3</sup>

**Gross weight/Peso lordo:**

ca 15,00 Kg.

**Box size/Dimensioni imballo:**

680×730×770 mm

**COM: 1,00 m H 140 COL: Upon request/su richiesta**

**In case of fabric or leather supplied by the customer, please contact us to verify the production feasibility prior to the start of the order. Confirmation of the amount of fabric or leather needed comes confirmed on offer or order confirmation.** / In caso di tessuto o pelle forniti dal cliente, vi preghiamo di contattarci per verificare la fattibilità produttiva precedentemente all'inizio dell'ordine. La conferma della quantità del tessuto o pelle necessari viene confermata su offerta o conferma d'ordine.

**Designer: atelier oï**



**Founded in 1991 by Aurel Aebi, Armand Louis and Patrick Reymond, atelier oï is a trio built on shared values and ideals, with projects ranging from architecture and interior design to product design, but always with the same holistic, transdisciplinary vision.**

Fondato nel 1991 da Aurel Aebi, Armand Louis e Patrick Reymond, atelier oï è un trio animato dalla condivisione di valori e ideali, con progetti che spaziano dall'architettura, al product design, all'interior design, sempre con una visione multidisciplinare e olistica.

## Woods/Legni

---

### Ash/Frassino



White Ash  
Frassino Bianco



Natural Ash  
Frassino Naturale



Dark Wengè  
Ash / Frassino  
Dark Wengè



Walnut Ash  
Frassino Noce



Black Ash  
Frassino Nero

## Fabrics/Tessuti

---

### Cat. A

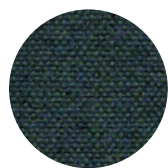

Main line flax  
+41 colors/colori



Natur Wool  
+28 colors/colori



Nord Wool  
+21 colors/colori

### Cat. B

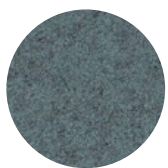

Blazer  
+49 colors/colori

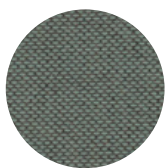

Re-wool  
+21 colors/colori



Synergy  
+75 colors/colori

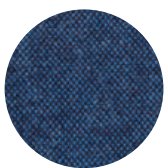

Wolin  
+47 colors/colori

### Cat. C

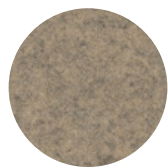

Divina Melange 3  
+38 colors/colori



Hallingdal 65  
+58 colors/colori



Molly 2  
+15 colors/colori



Remix 3  
+72 colors/colori

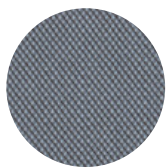

Steelcut Trio 3  
+54 colors/colori

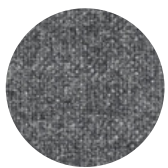

Tonica 2  
+39 colors/colori

## Leather/Pelle

---

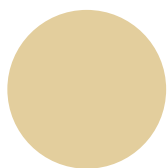

Leather/Pelle  
Elmosoft

---

## Warnings/Avvertenze

Indoor use only

Avoid standing on the product;  
Do not use the product as a ladder;  
Do not swing or rock on the product;  
Do not hang weights on the armrests or protruding parts; Avoid any improper use that does not comply with the correct one;

Prodotti per interni

Evitare di stare in piedi sul prodotto;  
Non utilizzare il prodotto come scala;  
Non oscillare o dondolarsi sul prodotto;  
Non appendere pesi sui braccioli o parti sporgenti; Evitare qualsiasi uso improprio non conforme a quello corretto;

---

## Recovery Start/Smaltimento

At the end of its use, the product must be destined for recovery according to the ordinary disposal channels.

Al termine del suo utilizzo, il prodotto deve essere destinato al recupero secondo i canali ordinari di smaltimento.

---

## Legal provisions/Disposizioni di legge

These instructions comply with Legislative Decree 206/2005, "Consumer Code" and with the European directives 85/374 / EEC, 1999/34 / EC and 1999/44 / EC.

Queste istruzioni sono conformi al D. lgs. 206/2005, "Codice del consumo" e con le direttive Europee 85/374/CEE, 1999/34/CE e 1999/44/CE.

---

## Care and maintenance/Cura e manutenzione

Clean the wooden parts with a very soft and dry cloth. In case of persistent dirt or stains, use small quantities of neutral soap, diluted in water (eg 2% soap 98% water) and then dry with a soft, dry cloth. To remove stains, never rub the surfaces with pressure. Never use products containing alcohol or ammonia. Avoid prolonged contact with any type of liquid and do not place the furniture near heat sources. For cleaning fabrics, in addition to normal suction, it is recommended to apply a specific product once or twice a year. To avoid stains, clean immediately using an absorbent cloth only.

Pulire le parti in legno con un panno molto morbido e asciutto. In caso di sporco persistente di macchie, utilizzare piccole quantità di sapone neutro, diluito in acqua (ad es. 2% di sapone 98% di acqua) e quindi asciugare con un panno morbido e asciutto. Per rimuovere le macchie non strofinare mai le superfici esercitando pressione. Non utilizzare mai prodotti contenenti alcol o ammoniaca. Evitare il contatto prolungato con qualsiasi tipo di liquido e non posizionare gli arredi vicino a fonti di calore. Per la pulizia dei tessuti, oltre alla normale aspirazione, si raccomanda di applicare una o due volte all'anno un prodotto specifico. Per evitare macchie, pulire immediatamente utilizzando solamente un panno assorbente.

**Passoni Luigi Sedie Srl – Passoni Design**  
**refuse any responsibility for damages caused to persons or things deriving from an improper use of the product.**

**Passoni Luigi Sedie Srl – Passoni Design declina qualsiasi responsabilità per danni causati a persone o cose derivanti da un uso improprio del prodotto.**